

Tweeter · Hochtöner
hifiAMT®17D2.2

Preis/Price 199,90 €

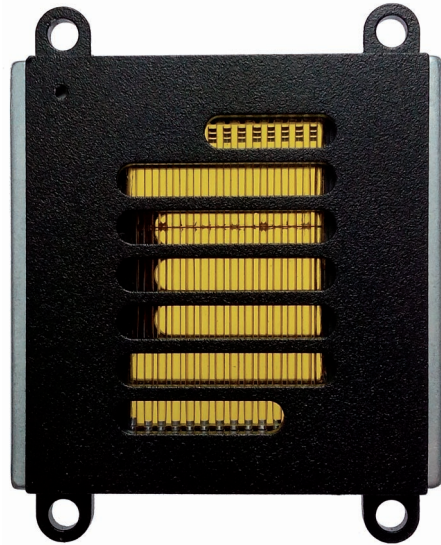

Dipol zur freien Aufstellung. Einsatz als Super-Hochtöner für vorhandene Lautsprecher oder als frei aufgestellter Hochtöner für Dipol-Systeme.

- Keine Schallwand notwendig • Linear bis 31 kHz

Free-standing Dipole. Usable as a super tweeter for existing speaker systems or as free standing tweeter in dipole systems.

- No baffle required • Frequency Range up to 31 kHz

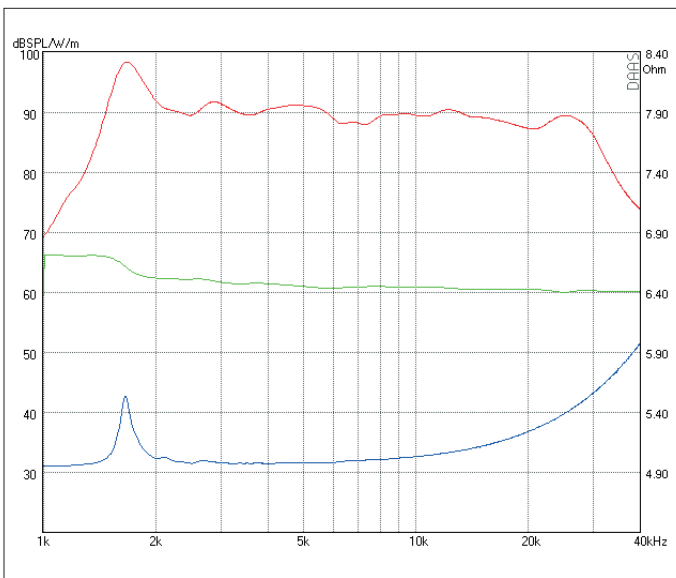

SPL 2.83 V - Phase - Impedance

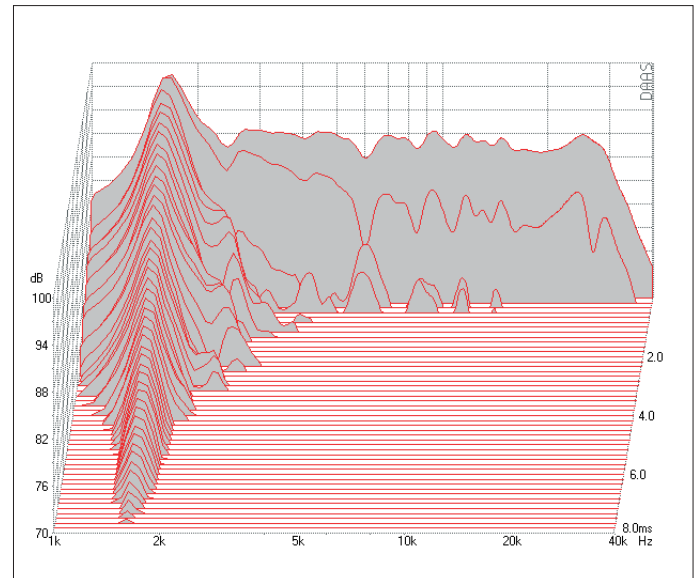

Waterfall

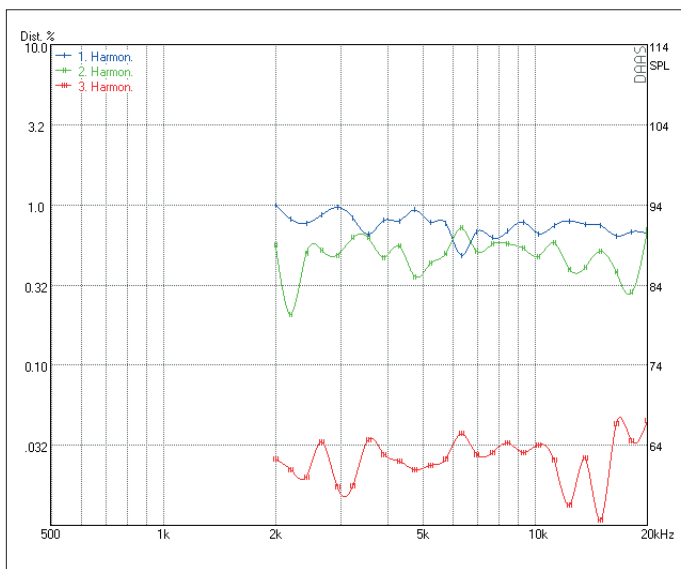

Harmonic Distortion 2.83 V

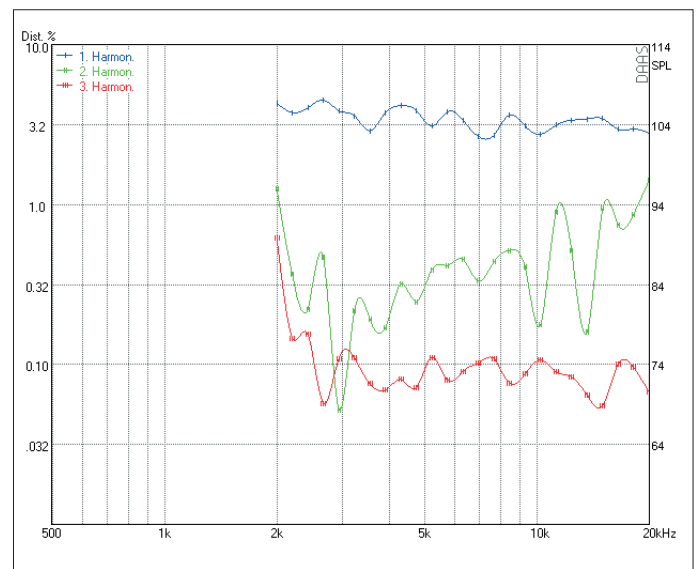

Harmonic Distortion 105 dB

RESISTANCE	NOMINAL 4 OHM
Z ₀ 5.2 OHM • Z _{min} 4.7 OHM • RE 4.7 OHM	
SENSITIVITY @ 2.83 V	90 dB
FREQUENCY RESPONSE / -6 dB	1300Hz - 31 kHz
POWER HANDLING	60 W
RESONANCE FREQUENCY / FS	1700 Hz
RECOMMENDED CROSSOVER / 6 dB	5000 Hz
RECOMMENDED CROSSOVER / 12 dB	4000 Hz
DISPERSION HORIZONTAL / 15 kHz / -6 dB	60°
DIAPHRAGM AREA	1260 mm ²
MAGNET MATERIAL	NEODYMIUM
FACE PLATE	non

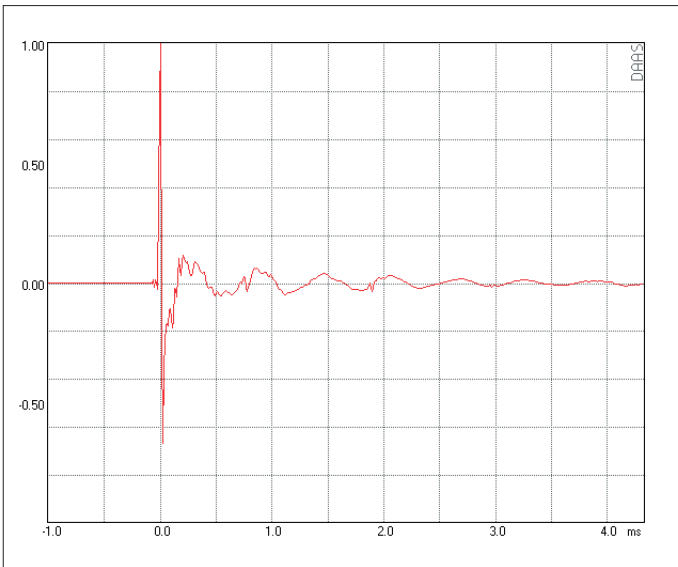
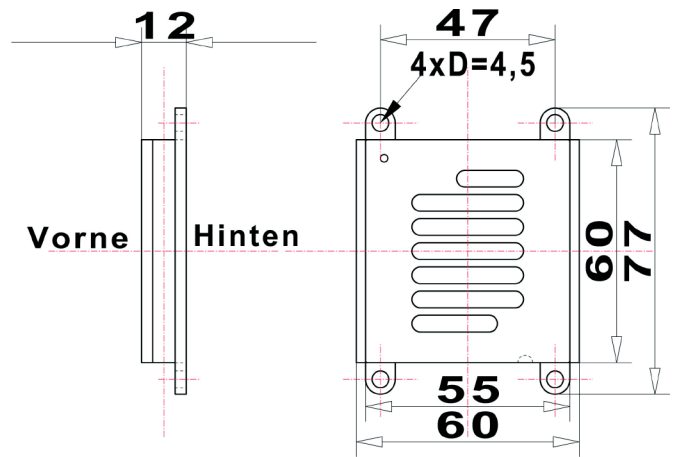

Impulse Response

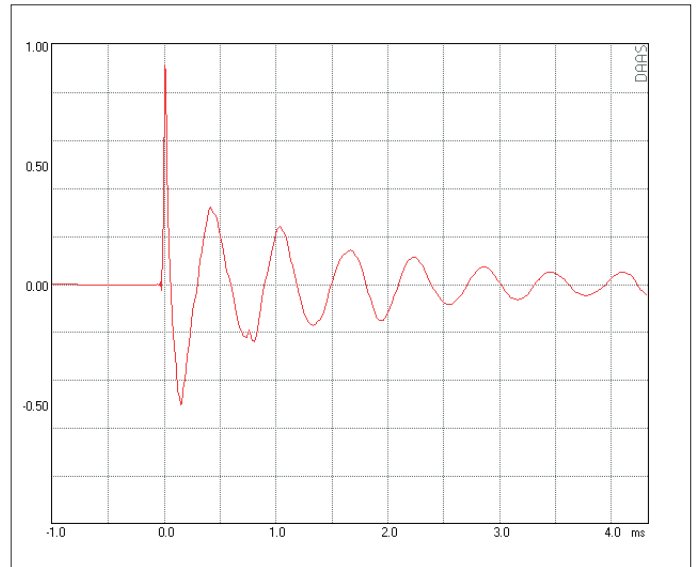

Step Response

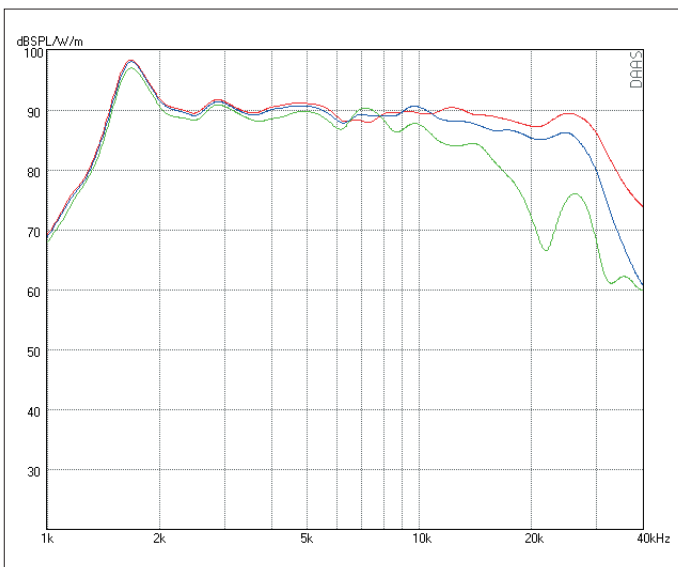

SPL HORIZONTAL 0° - 15° - 30°

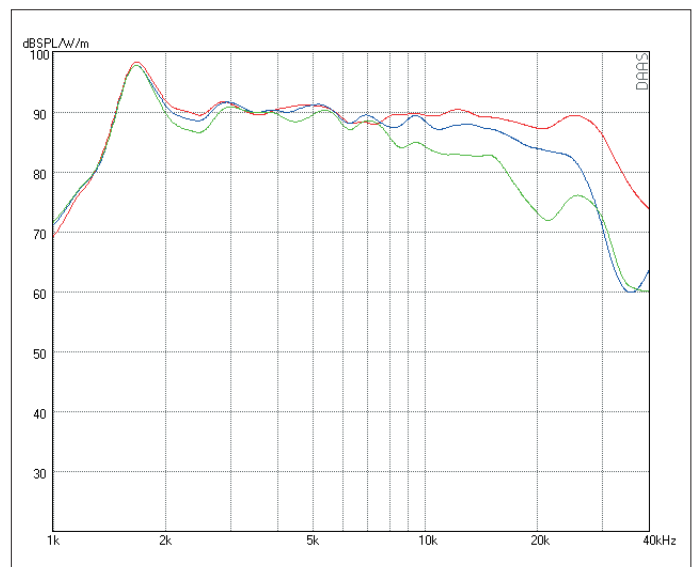

SPL VERTIKAL 0° - 5° - 15°